

Keystone Agility Club

Sat, Sept 4, 2021

Advanced/P2 Gamblers

David Bozak

-40 -30 -20 -10 0 10 20 30 40

no obstacles back to back

90 90

80 80

70 70

60 60

50 50

40 40

30 30

20 20

10 10

-40 -30 -20 -10 0 10 20 30 40

gate

T/S

gate

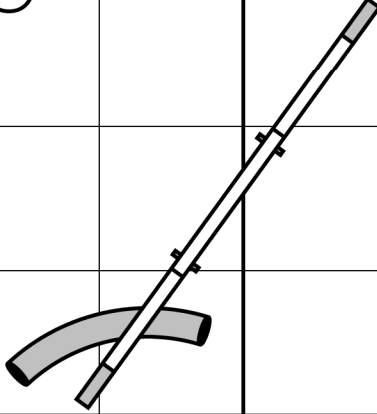
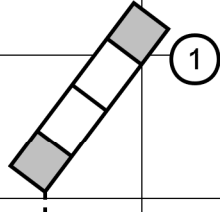
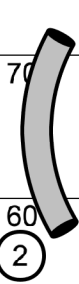

3

4

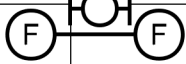

1-2-3-5 system
Dogwalk worth 5 pts
25 s. opening
13 pts. needed

joker worth 15 pts.
closing times:
20"/22"/24" get 17 s.
14"/16" get 18 s.
12"/10" get 19 s.
Perf +1 s.

S

S

start is
bidirectional

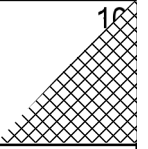

Keystone Agility Club

Sat, Sept 4, 2021

Starters/P1/Intro Gamblers

David Bozak

-40 -30 -20 -10 0 10 20 30 40

no obstacles back to back

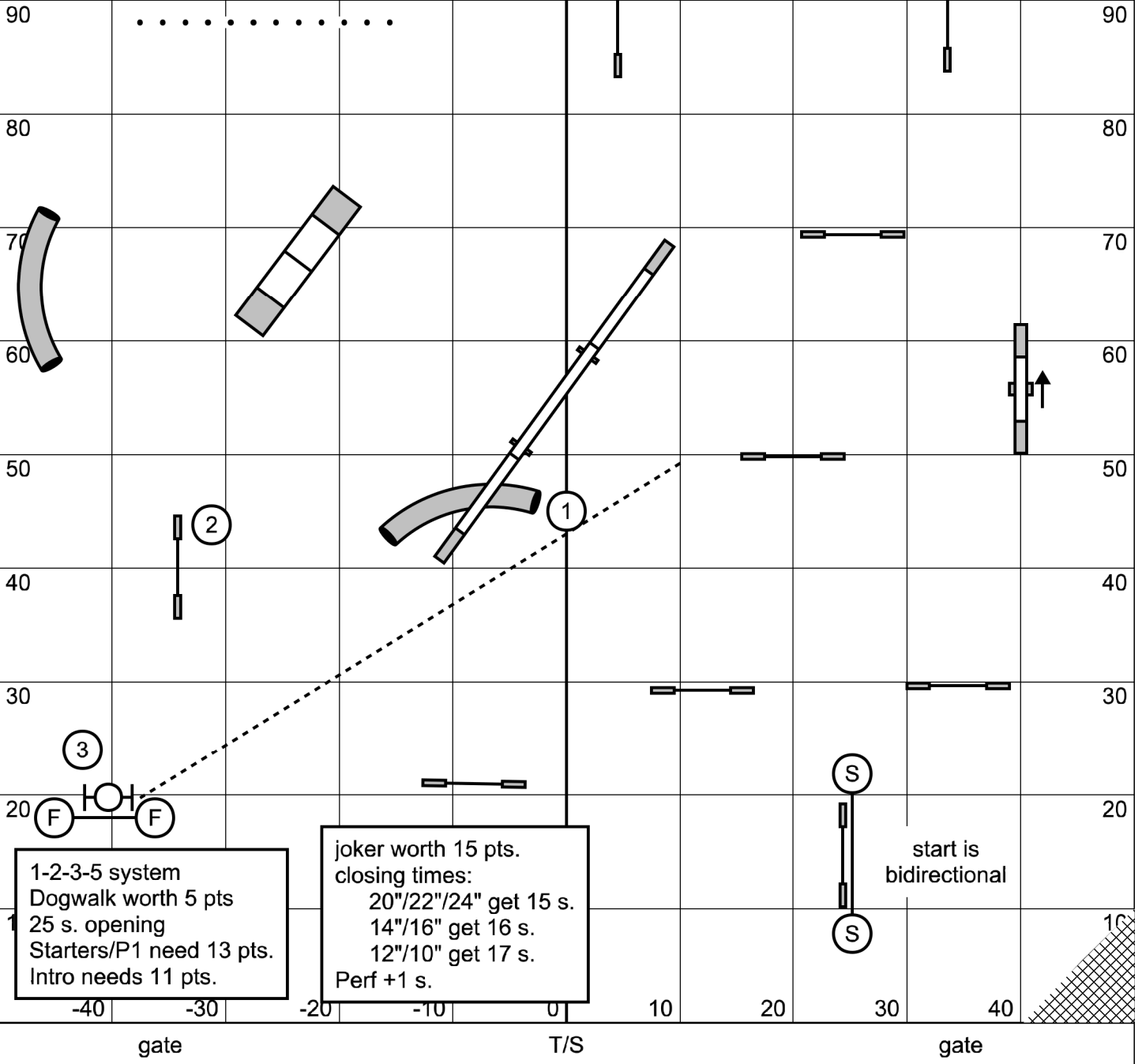

Keystone Agility Club

Sat, Sept 4, 2021

Masters/P3/Vets Standard

David Bozak

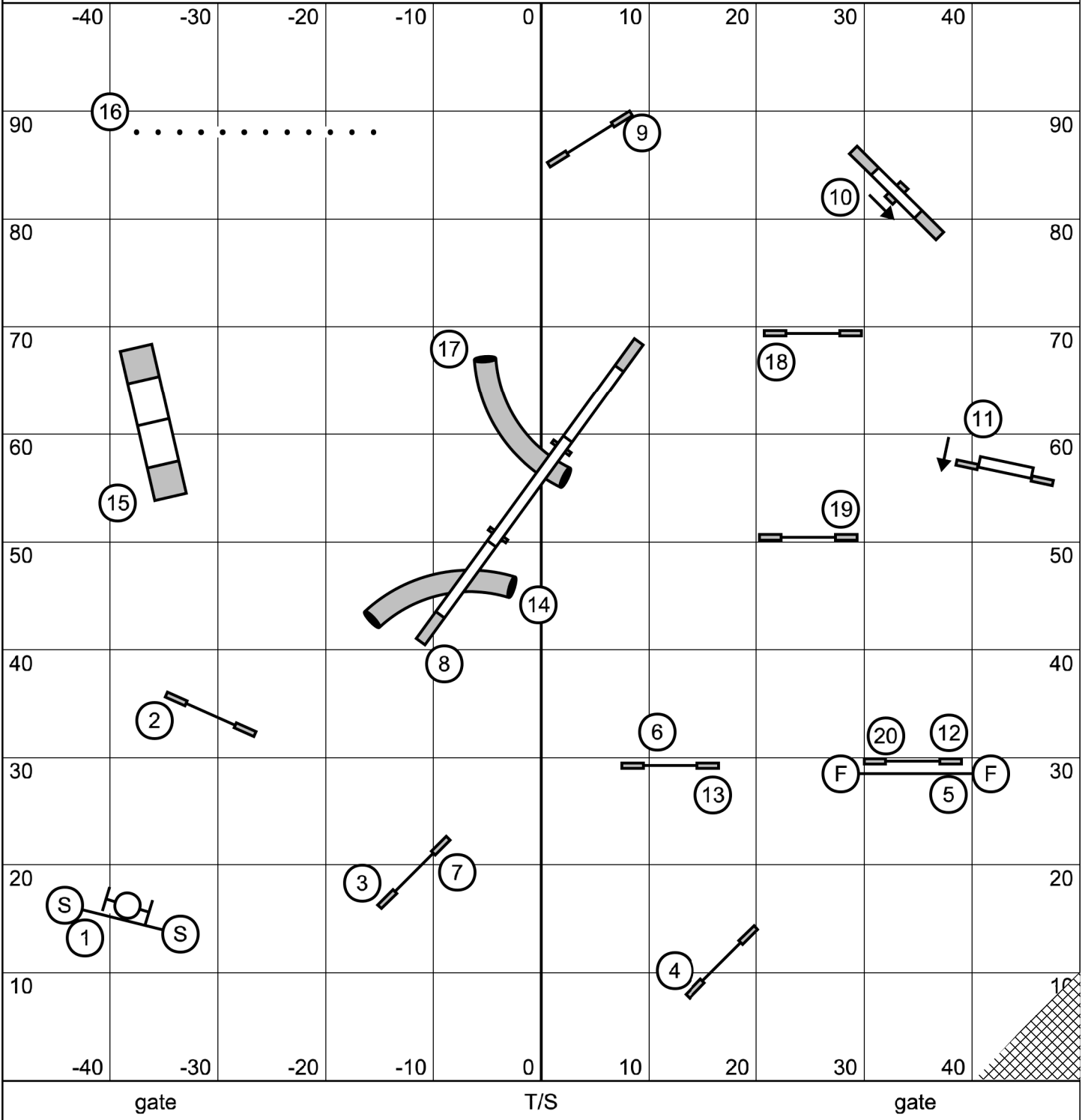

Keystone Agility Club

Sat, Sept 4, 2021

Advanced/P2 Standard

David Bozak

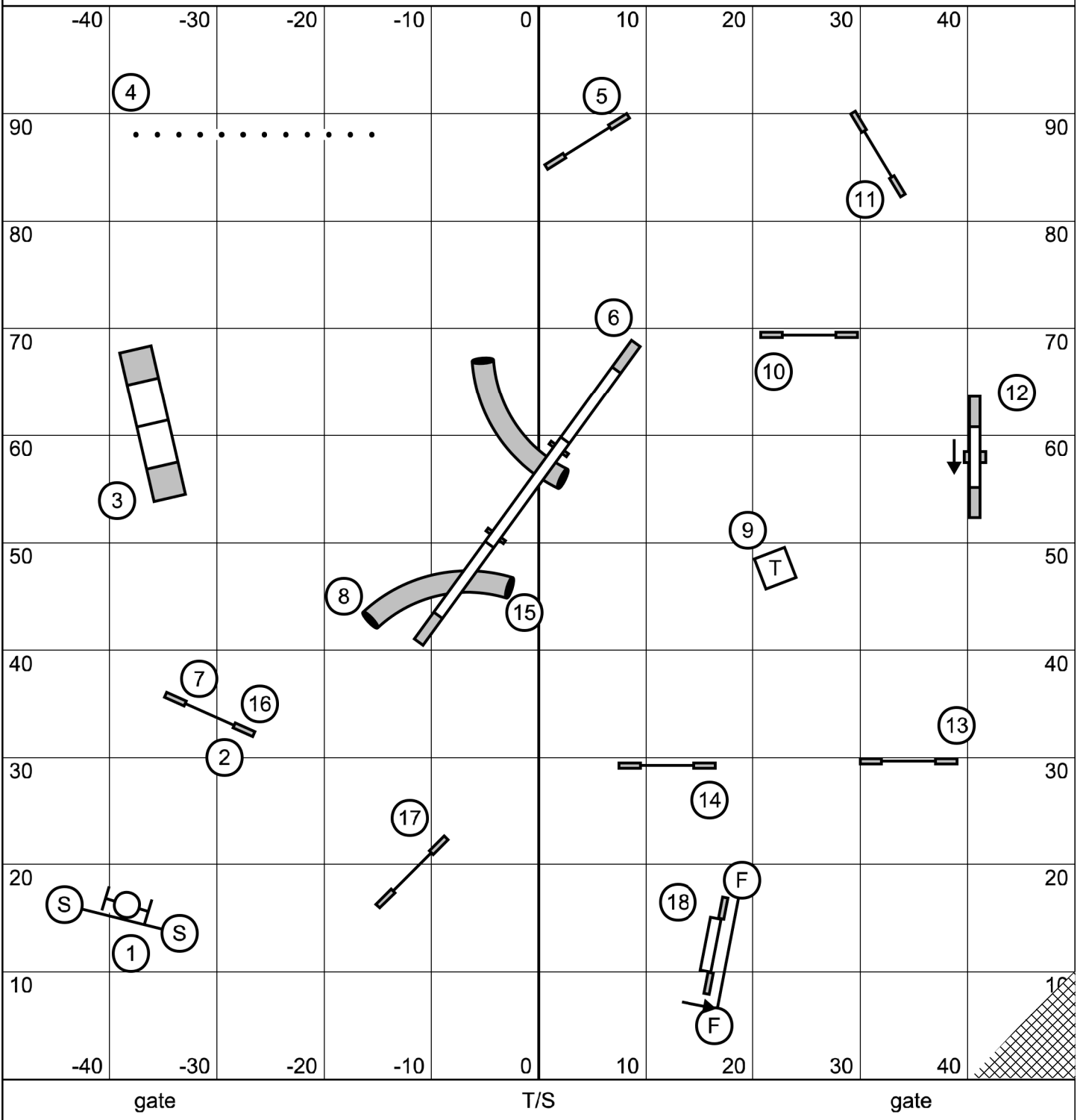

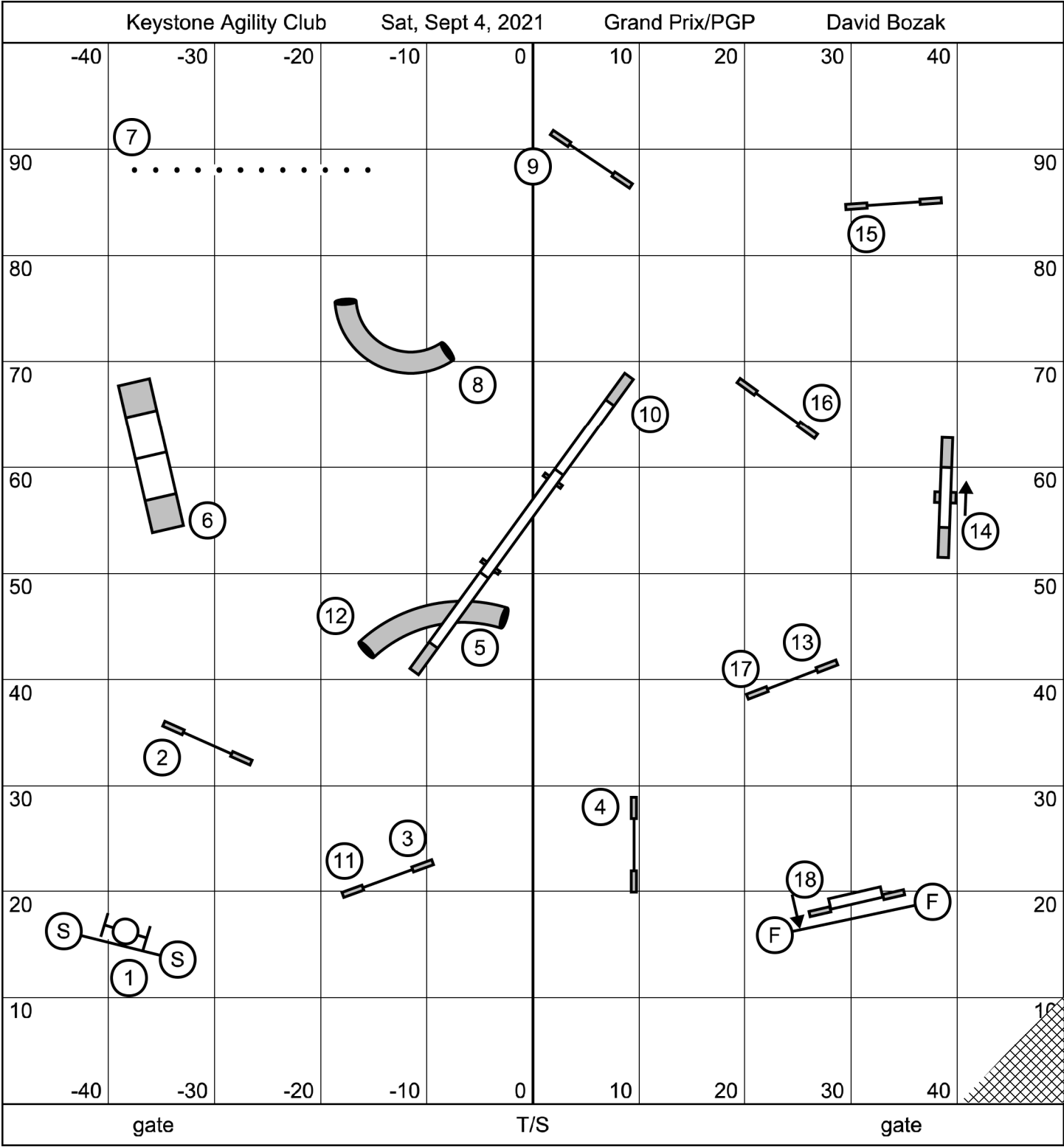

Eat An Extra Dessert Day!

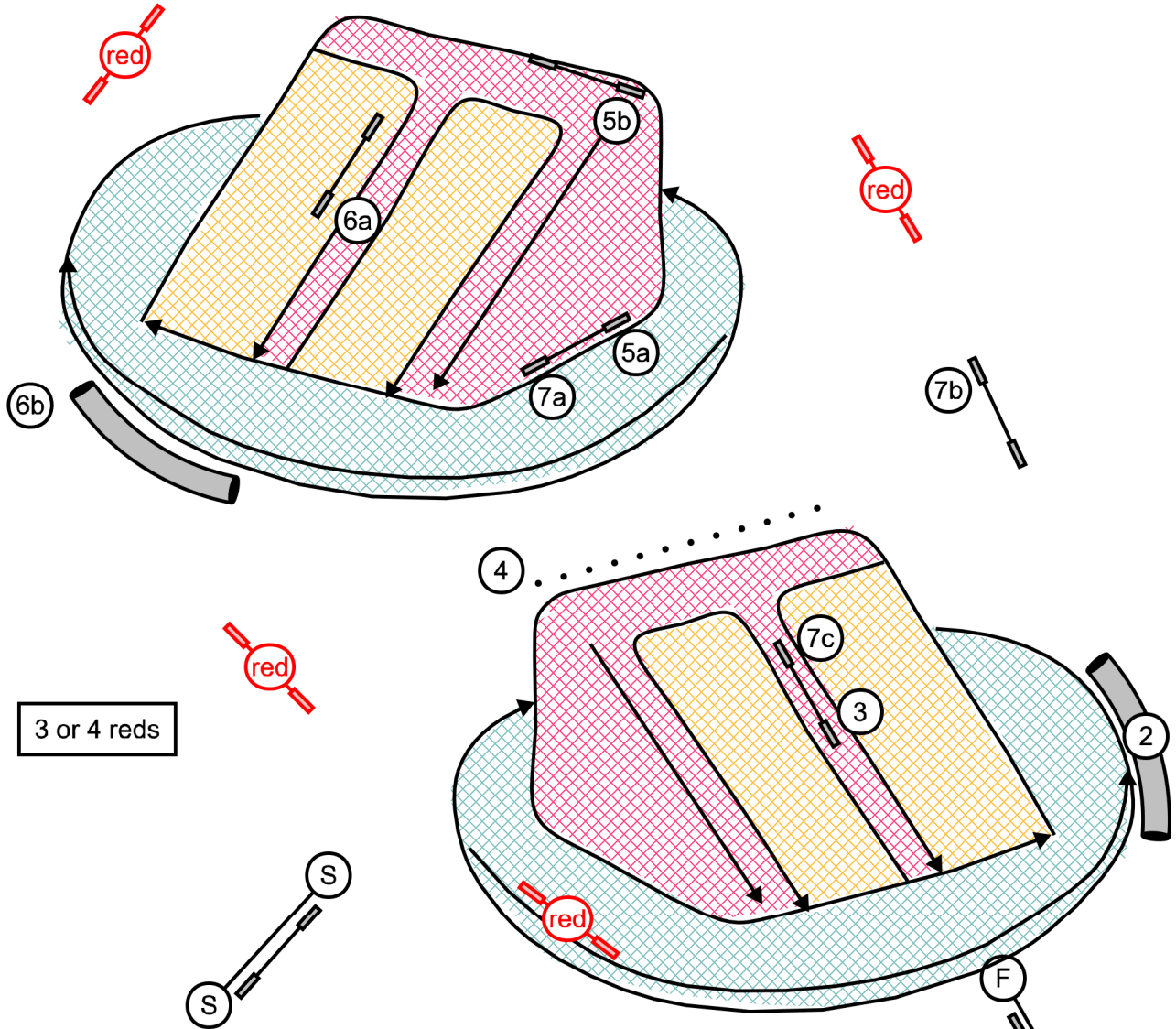

In the opening, obstacles are bidirectional, combos taken in any order, any direction, each element of a combo to be taken once else tweet.
 In the closing, #2 is bidirectional and all other obstacles to be taken as numbered.

20"/22"/24" get 50 s.
 14"/16" get 52 s.
 10"/12" get 54 s.
 Perf +2 s., Vets +4 s.

gate

T/S

gate

Eat An Extra Dessert Day!

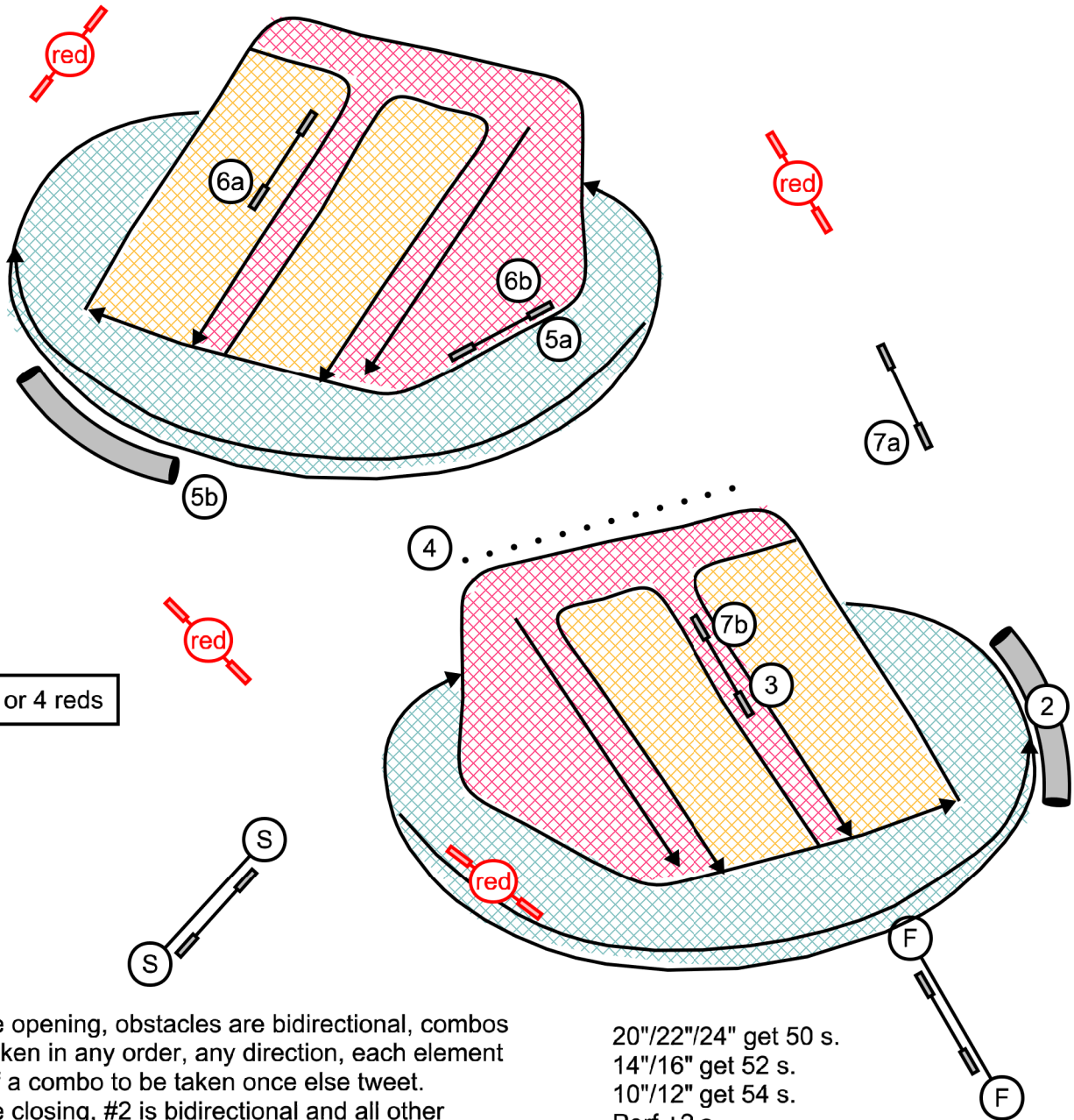

3 or 4 reds

In the opening, obstacles are bidirectional, combos taken in any order, any direction, each element of a combo to be taken once else tweet.
 In the closing, #2 is bidirectional and all other obstacles to be taken as numbered.

20"/22"/24" get 50 s.
 14"/16" get 52 s.
 10"/12" get 54 s.
 Perf +2 s.

gate

T/S

gate

Eat An Extra Dessert Day!

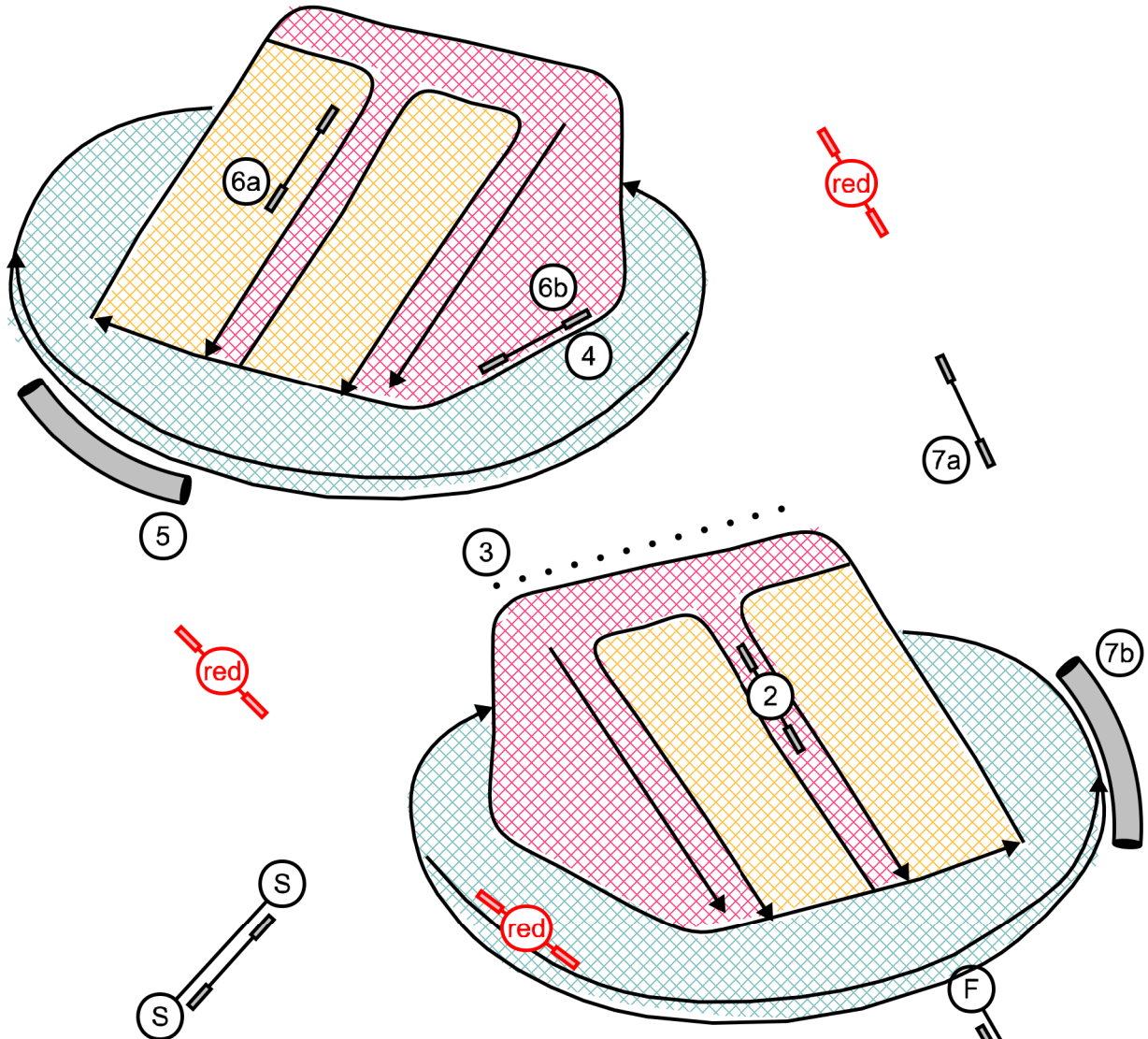

In the opening, obstacles are bidirectional, combos taken in any order, any direction, each element of a combo to be taken once else tweet.
 In the closing, #2 is bidirectional and all other obstacles to be taken as numbered.

20"/22"/24" get 50 s.
 14"/16" get 52 s.
 10"/12" get 54 s.
 Perf +2 s.

gate

T/S

gate

Keystone Agility Club

Sat, Sept 4, 2021

Combined Pairs

David Bozak

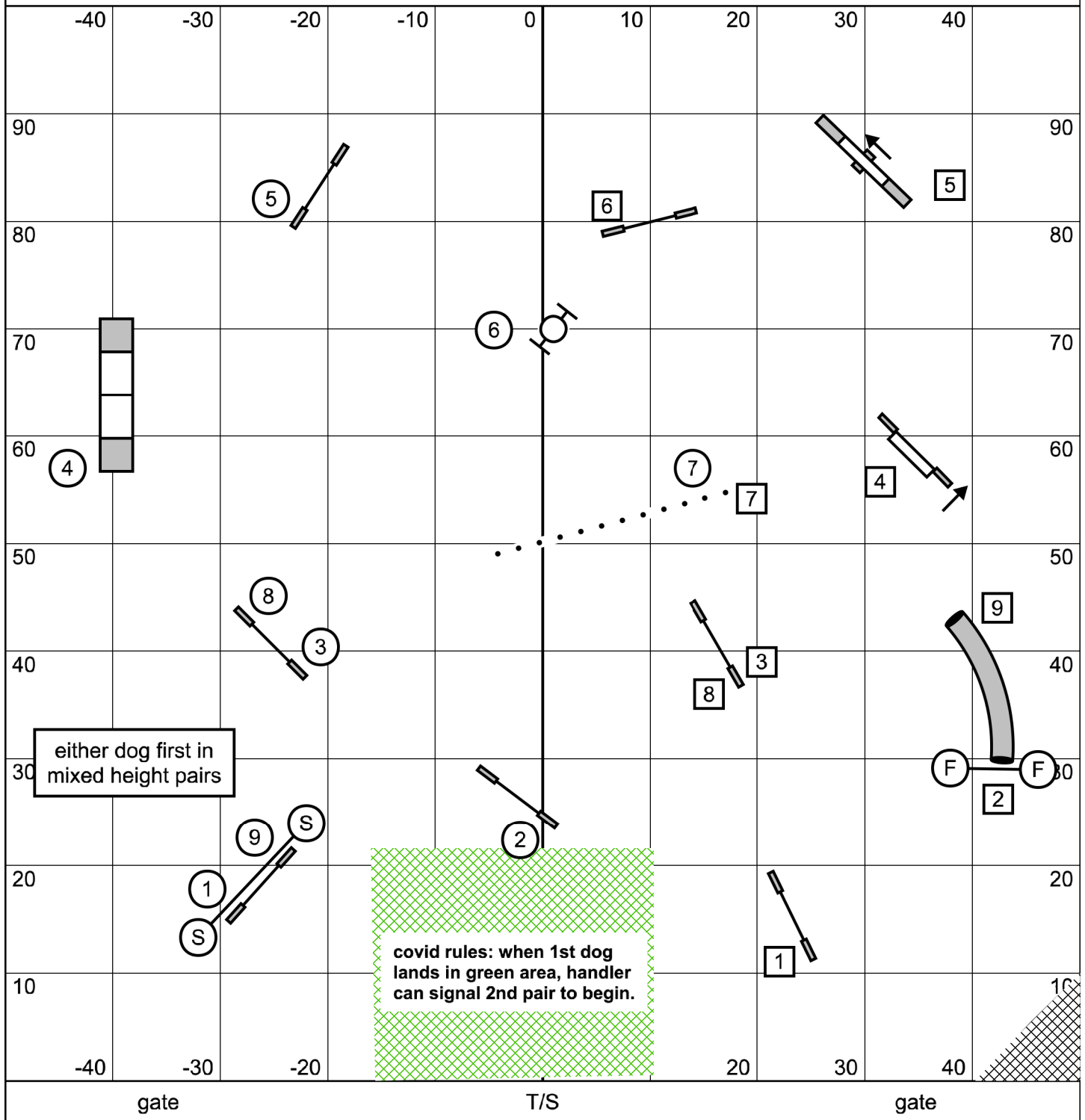

either dog first in mixed height pairs

covid rules: when 1st dog lands in green area, handler can signal 2nd pair to begin.

gate

T/S

gate